

REV	DESCRIPTION	DESIGN	DATE
A	NEW RELEASE	Z.M.Xue	2023.05.24

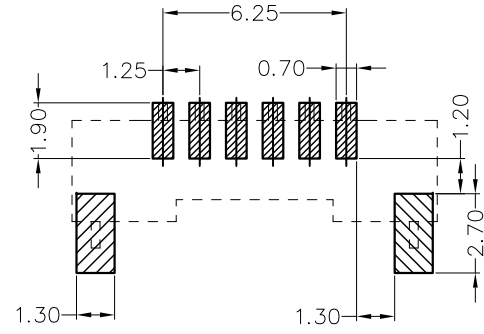

PCB LAYOUT(Tolerance:±0.05)

Specifications:
 Contact resistance: ≤20mΩ
 Insulation resistance: ≥100MΩ
 Rated voltage: 125V AC DC
 Rated current: 1.0A AC DC
 Withstand Voltage: 500V AC/minute
 Temperature Range: -25°C ~ +85°C
 Housing: LCP UL94V-0, Black
 Contacts: Brass/MATTE Sn
 Solder Tabs: Brass/MATTE Sn

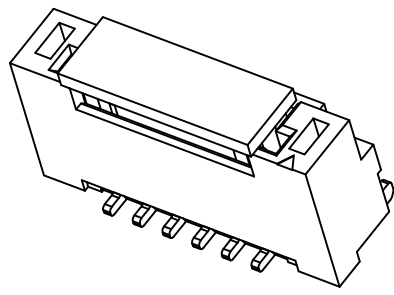
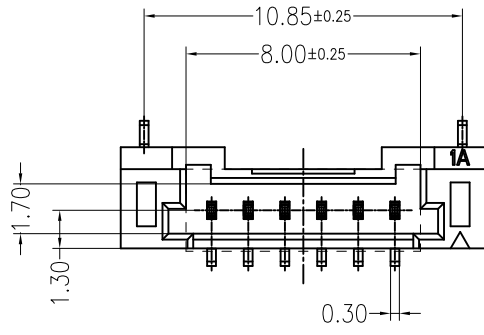
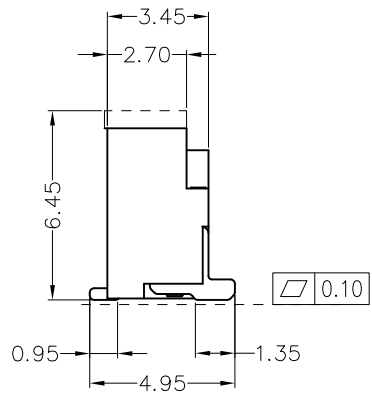
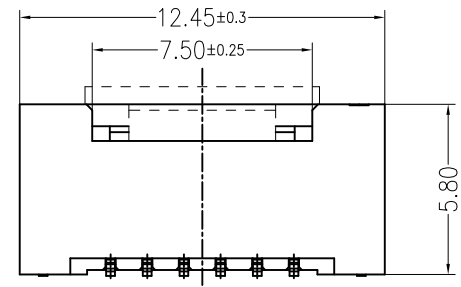

ORDER INFORMATION:

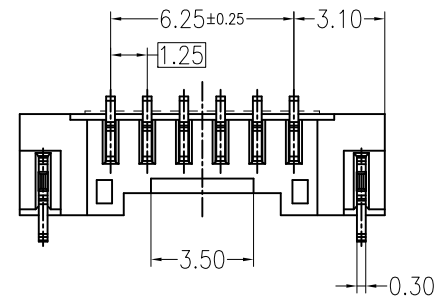
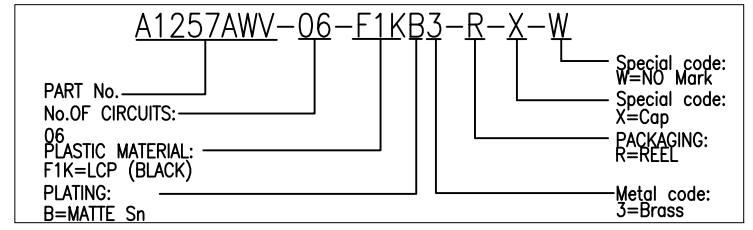

JKUN 温州健坤接插件有限公司 WENZHOU JKUN CONNECTOR CO.,LTD.		TITLE: 1.25 Pitch Wafer 180° SMT	
GENERAL TOLERANCE		USE: CUSTOMER	PART NO.:
X. ±0.50	X. ±5°	APPD: Zhu Zhigang	A1257AWV-06-F1KB3-R-X-W
X.X ±0.30	X.X ±2°	CHKD: Yan Peng	DWG NO.:
X.XX ±0.20	X.XX ±1°	DR: Z.M.Xue	JKUN-GCKH-0840
UNITS: mm		SCALE 1 : 1	SHEET 1 / 1

REV	DESCRIPTION	DESIGN	DATE
A	NEW RELEASE	FangSongLe	2019/12/10

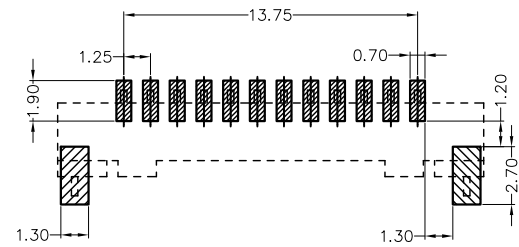
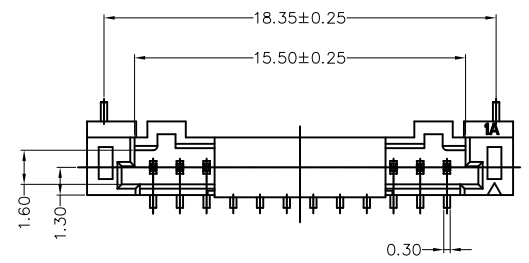

PCB LAYOUT(Tolerance:±0.05)

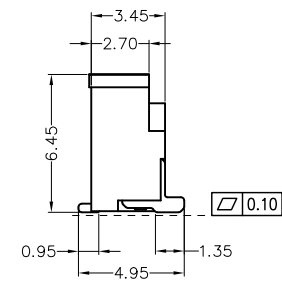
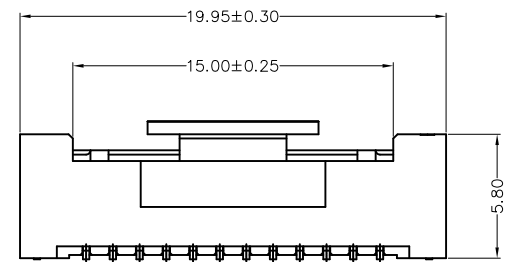

Specifications:
 Contact resistance: ≤20mΩ
 Insulation resistance: ≥100MΩ
 Rated voltage: 125V AC DC
 Rated current: 1.0A AC DC
 Withstand Voltage: 500V AC/minute
 Temperature Range: -25°C ~ +85°C
 Housing: LCP UL94V-0, Natural
 Contacts: Brass/MATTE Sn
 Solder Tabs: Brass/MATTE Sn

ORDER INFORMATION:

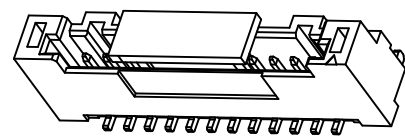
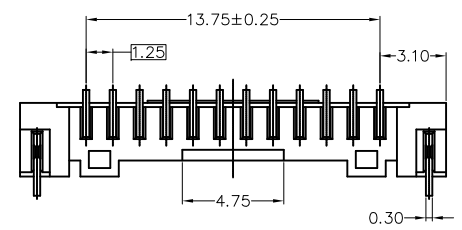
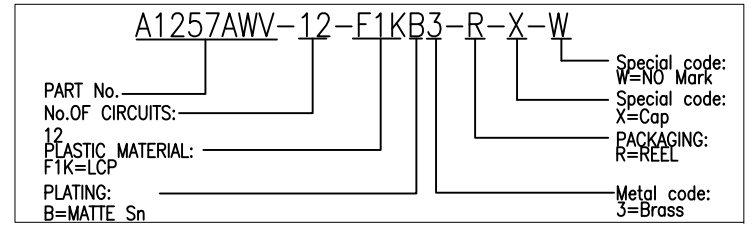

JKUN 温州健坤接插件有限公司 WENZHOU JKUN CONNECTOR CO.,LTD.		TITLE: 1.25 Pitch Wafer 180° SMT	
GENERAL TOLERANCE		USE: CUSTOMER	PART NO.:
X. ±0.50	X. ±5°	APPD: Steven	A1257AWV-12-F1KB3-R-X-W
X.X ±0.30	X.X ±2°	CHKD: Liuzhengling	DWG NO.:
X.XX ±0.20	X.XX ±1°	DR: FangSongLe	JKUN-GCKH-0840
UNITS: mm		SCALE 1 : 1	SHEET 1 / 1

REV	DESCRIPTION	DESIGN	DATE
A0	NEW RELEASE	FangSongLe	2019/12/10

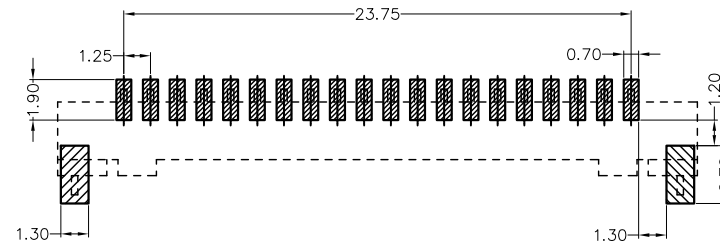
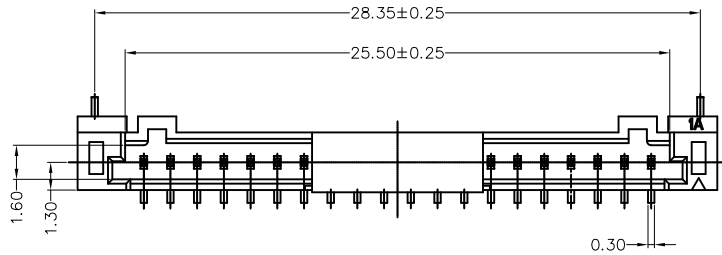

PCB LAYOUT(Tolerance:±0.05)

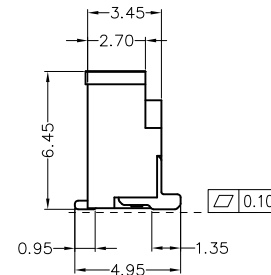
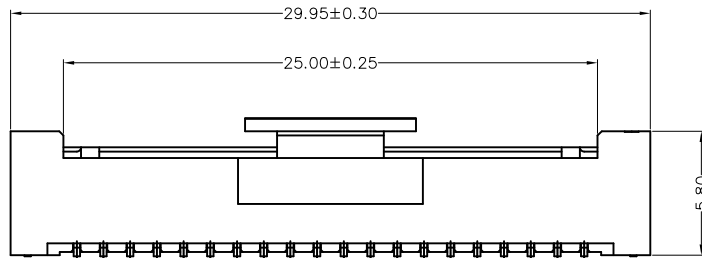

Specifications:

- Contact resistance: ≤20mΩ
- Insulation resistance: ≥100MΩ
- Rated voltage: 125V AC DC
- Rated current: 1.0A AC DC
- Withstand Voltage: 500V AC/minute
- Temperature Range: -25°C ~ +85°C
- Housing: LCP UL94V-0, Natural
- Contacts: Brass/MATTE Sn
- Solder Tabs: Brass/MATTE Sn

ORDER INFORMATION:

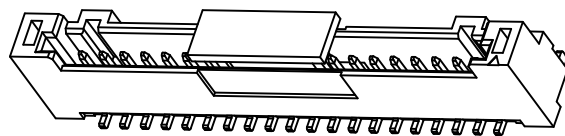
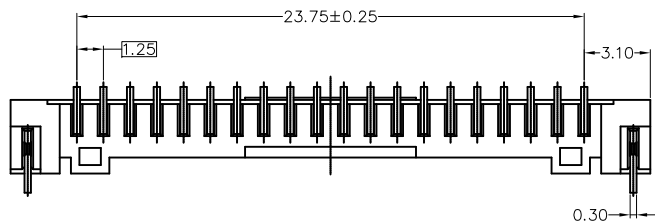
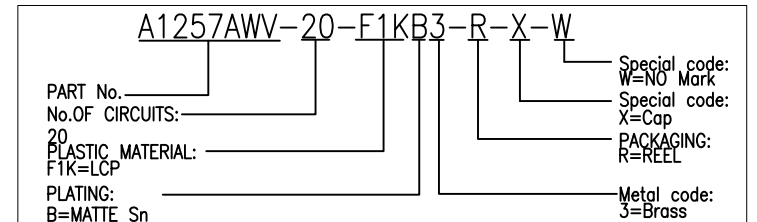

JKUN 温州健坤接插件有限公司 WENZHOU JKUN CONNECTOR CO.,LTD.		TITLE: 1.25 Pitch Wafer 180° SMT	
GENERAL TOLERANCE		USE: CUSTOMER	PART NO.:
X. ±0.50	X. ±5°	APPD: Steven	A1257AWV-20-F1KB3-R-X-W
X.X ±0.30	X.X ±2°	CHKD: Liuzhengling	DWG NO.:
X.XX ±0.20	X.XX ±1°	DR: FangSongLe	JKUN-GCKH-0840
UNITS: mm		SCALE 1 : 1	SHEET 1 / 1